

Part number:

006-10031

HYDROMA

HYDRAULICKÉ SYSTÉMY

**HIDROMA
SYSTEMS**

UKŁADY HYDRAULICZNE

HYDROMA

ГИДРАВЛИЧЕСКИЕ СИСТЕМЫ

**MANIFOLDS (SECTION 2)
SPECIAL CAVITY**

2 WAY STEEL

Inches
(mm)

CAVITY	017-E
Dimensions on page	CT.S.005.U

ORDERING CODE	PORTS	WEIGHT
	A-B	Lbs (Kg)
OC.10.09.074	G 1/2	1.984 (0.900)
OC.10.09.073	G 3/4	1.984 (0.900)

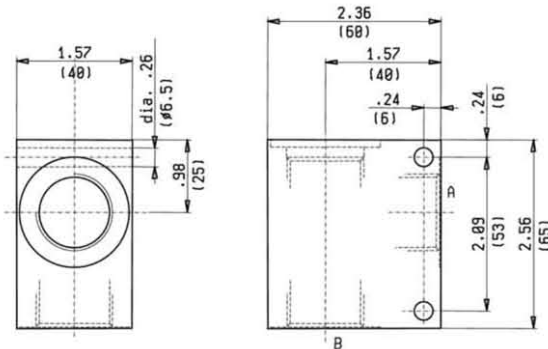

CAVITY	021-E
Dimensions on page	CT.S.005.U

ORDERING CODE	PORTS	WEIGHT
	A-B	Lbs (Kg)
OC.10.09.075	G 3/4	2.866 (1.300)
OC.10.09.076	G 1	2.866 (1.300)

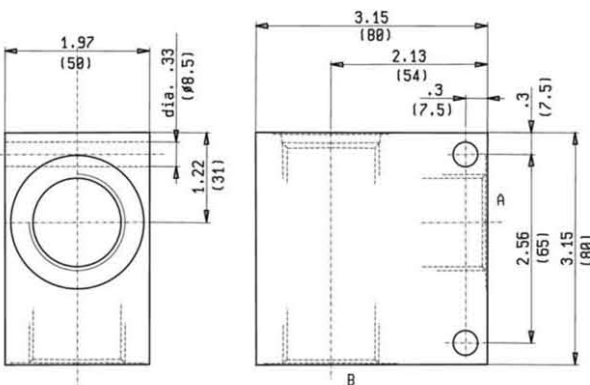

MAX. PRESSURE	6500 psi (450 bar)	FEATURES
		These manifolds can be supplied upon request for working pressures up to 6500 psi (450 bar) and for fatigue cycle applications.

Rev.05.05

MN2.S.002.U